

MLA1000

Conductivity Meter for Flowing Light Oil



Description

Installation

Operation



Document information

Described product

Product name: MLA1000

Document identification

Title: MLA1000 Operating Instructions

Order number: 8011607

Version: 1.0

Date: 2019-10

Publisher

MBA Instruments GmbH

Friedrich-List-Str. 3-725451 Quickborn · Germany

Phone: +49 (0) 41 06 123 888-0

Fax: +49 (0) 41 06 123 888-9

Email: info@mba-instruments.de

Warranty information

The stated product characteristics and technical data do not constitute warranty declarations.

© MBA Instruments GmbH. All rights reserved.

Glossary

ATEX Atmosphères explosibles: Abbreviation for European standards relating to safety in explosion-endangered areas

DC Direct current

IP xy International protection (also: Ingress Protection); protection class for a device pursuant to IEC/DIN EN 60529.

PE Polyethylene

PUR Polyurethane

PVC Polyvinyl chloride

TPE Thermoplastic elastomer

Warning symbols



Hazard (general)



Hazard from electrical voltage



Hazard in explosion-endangered areas



Hazard from explosive substances/ substance mixtures



Hazard from noxious substances

Warning levels/signal words

WARNING

Hazard situation for people that could result in serious injuries or death.

CAUTION

Hazard that could result in less serious or minor injuries and/or risk of damage to property.

IMPORTANT

Hazard possibly resulting in damage to property.

Information symbols



Important technical information for this product



Important information about explosion-endangered areas



Tip



Additional information



Reference to information elsewhere

Content

1	Safety Instructions	5
1.1	Important instructions for safe usage	5
1.2	Principal installation instructions	5
1.3	Principal operating instructions	5
1.4	Responsibilities of the user	6
1.4.1	Only allow installation and use by specialist technicians	6
1.4.2	Correct use	6
1.4.3	Consideration of local conditions	6
1.4.4	Safekeeping of the documentation	6
2	Product Description	7
2.1	Intended usage	7
2.1.1	Intended scope of application	7
2.1.2	Application restrictions	7
2.1.3	Certification for explosion-endangered areas	7
2.2	Operating principle	8
2.3	Product components	9
2.3.1	MLA1000-S measuring probe	9
2.3.2	MLA1000-A display unit	9
2.3.3	MLA1000-K probe cable	9
2.3.4	Options	9
2.4	Scope of delivery	10
3	Installation of the Measuring Probe	11
3.1	Selecting the installation location for the measuring probe	11
3.1.1	Requirements for the measuring liquid at the installation location	11
3.1.2	Requirements for the installation location	11
3.2	Preparing the piping system	12
3.3	Installation of the measuring probe with immersion pipe	12
4	Installation of the Display Unit	14
4.1	Mounting the display unit	14
4.1.1	Criteria for the mounting location	14
4.1.2	Securing the display unit without a mounting bracket	14
4.1.3	Securing the display unit with a mounting bracket	14
4.2	Connecting the potential equalisation	15
4.3	Opening the housing	15
4.4	Installing the cables	16
4.4.1	General information about installing the cables	16
4.4.2	Connecting the probe cable	16
4.4.3	Connecting the measurement reading outputs	16
4.4.4	Connecting the supply voltage	17
4.4.5	Closing the cable glands and housing	17
5	Operation	18
5.1	Putting the MLA1000 into operation	18
5.2	Checking the operating status	18
5.2.1	Indications for a safe operating status	18
5.2.2	Indications for an unsafe operating status	18
5.3	Display screens	18
5.3.1	Screen after switching on	18
5.3.2	Operating screen	18
5.3.3	Malfunction screens	19
6	Maintenance	21
6.1	Removing the immersion pipe (with measuring probe)	21
6.2	Testing the measuring function	21
6.3	Cleaning the measuring probe	22
6.4	Reinstalling the measuring probe	22
7	Troubleshooting	23
7.1	If the MLA1000 does not function at all	23
7.2	If the measurement readings are obviously incorrect	23
8	Appendix	24
8.1	Technical data	24
8.1.1	MLA1000-S measuring probe	24
8.1.2	MLA1000-A display unit	24
8.1.3	MLA1000-K probe cable	24
8.2	Certification/suitability test	24
8.3	Disposal Information	25

1 Safety Instructions

1.1 Important instructions for safe usage

- ▶ Only use the MLA1000 in explosion-endangered areas if permitted by the specifications for the zone, explosion group and temperature class (refer to the type plate on the display unit and measuring probe).
- ▶ Pay attention to and heed the "special conditions" stated on the type examination certificate.
- ▶ Installation, commissioning, maintenance and testing may only be carried out by technicians who possess requisite knowledge of the rules and regulations for explosion-endangered areas, e.g.
 - zoning
 - types of ignition protection
 - installation regulations, e.g. "Ordinance on electrical systems in explosion-endangered locations (ElexV)"
- ▶ Do not alter the product. Repairs may only be carried out by the manufacturer or by trained and authorised technicians.
- ▶ *If the product was delivered with special information about it:* Pay preferential attention to any special information.

1.2 Principal installation instructions



IMPORTANT:

- ▶ Install the measuring probe so that the liquid flows past the probe in the required direction (→ p.14, Fig. 3).

- ▶ Only use measuring probes and probe cables that have been approved by the manufacturer for the intended measuring liquid.
- ▶ Only put the MLA1000 into operation when the entire housing and all the cable glands have been correctly sealed.

1.3 Principal operating instructions



Intended usage → p.7, section 2.1.



Do not use the measurement readings if the requirements for the installation location of the measuring probe have not been fulfilled, in particular if the flow velocity of the measuring liquid is not within the specified range (→ p.7, section 2.1.1).



IMPORTANT:

- ▶ *In explosion-endangered areas:* Only open the terminal box for the display unit (bottom part of the housing) after the supply voltage and all external power supplies have been switched off.

- ▶ *If the measuring probe could become soiled during operation:* Clean the probe at regular intervals (→ p.22, section 6.3).
- ▶ *If the measurement readings cannot be correct:* Check whether the measuring probe is soiled.
- ▶ If necessary, clean the probe.

1.4 Responsibilities of the user

1.4.1 Only allow installation and use by specialist technicians

- ▶ Make sure that the MLA1000 is only installed and used by specialist technicians who, on account of their specialist training and knowledge and their familiarity with the applicable regulations, are able to assess the work assigned to them and recognise any hazards.

This applies in particular to:

- safety in explosion-endangered areas
- welding work
- handling of combustible substances

1.4.2 Correct use

- ▶ Only use the product as described in these operating instructions. The manufacturer will bear no responsibility for any deviating usage.
- ▶ Carry out the described maintenance work.
- ▶ Do not carry out any work or repairs on the product which are not described in these operating instructions.
- ▶ Do not remove, add or alter any components belonging to the product unless stipulated in official information provided by the manufacturer. Otherwise,
 - the manufacturer's warranty will become void,
 - the product could become dangerous,
 - the certification for use in explosion-endangered areas will become void.

1.4.3 Consideration of local conditions

- ▶ All local legislation, technical rules and operating regulations that apply at the location where the product is to be used must be observed in addition to these operating instructions.

1.4.4 Safekeeping of the documentation

- ▶ These operating instructions and all the supplied documentation must be kept available for reference purposes.
- ▶ Give the documentation to the new owner.

2 Product Description

2.1 Intended usage



IMPORTANT:

- ▶ If the product was delivered with special information about it:
- ▶ Pay preferential attention to any special information.

2.1.1 Intended scope of application

Measuring function

The MLA1000 is designed for continuously measuring the electrical conductance and temperature of suitable flowing measuring liquids. Suitable measuring liquids: kerosene, light fuels, lubricants, coolants, various chemical liquids.



It can only be guaranteed that the MLA1000 will function as intended when used in *flowing light fuel* at a flow velocity of *at least 0.2 m/s*.

Application purpose

Liquids can become electrostatically charged during filling, pumping or filtration. In the presence of an ignitable gas mixture in the ambient environment, there is also a risk that the gas mixture will be ignited (i.e. explode) by discharge sparks. This risk is assessed by measuring the electrical conductance of the liquid (see DIN 51 412-T02-79 "Determining electrical conductance, field procedure").



The conductance is stated using the physical unit "pS/m" (picosiemens per meter). The unit "c.u." (conductivity unit), which is still frequently used in the oil industry, has an equal value:
 1 pS/m = 1 c.u.

2.1.2 Application restrictions

- ▶ Only use the MLA1000 for measuring suitable measuring liquids.
- ▶ The measuring liquid must meet certain requirements (→ p.11, section 3.1.1).
- ▶ Heed the supplied manufacturer's information regarding restrictions and suitability. Unsuitable liquids (e.g. acids, chlorinated hydrocarbon solvents) can damage the measuring probe and probe cable.



WARNING: Risk of incorrect measurements

The measuring liquid must fulfil the stipulated requirements for the measuring probe at the installation location (→ p.11, section 3.1.1) as otherwise the readings will not be reliable.



- ▶ Make sure that the measuring fluid at the installation location of the measuring probe fulfils the stipulated requirements.
- ▶ *If the conductance measurement reading is being used to monitor the safe usage of the measuring fluid (in particular for explosion protection purposes):* Make sure that the measurement readings are recognised as being invalid if the measuring liquid at the installation location of the measuring probe does not fulfil the stipulated requirements. If necessary, install appropriate safety mechanisms. Unsafe operating conditions could otherwise arise in the monitored system.

2.1.3 Certification for explosion-endangered areas

- The MLA1000-S measuring probe (→ p.9, section 2.3.1) is certified for installation in containers (e.g. piping systems) holding combustible liquids in Zone 0 hazardous areas.
- The MLA1000-A display unit (→ p.9, section 2.3.2) is certified for use in Zone 1 hazardous areas.



Numbers of the type examination certificates → p.24, section 8.2

2.2 Operating principle

- The measuring probe of the MLA1000 is installed in the container through which the measuring liquid flows (e.g. a piping system). The measuring liquid must meet certain requirements (→ p.11, section 3.1.1).
- The probe measures the conductance by sending an electrical current through the measuring liquid by means of low auxiliary voltage. The greater the conductance, the stronger is the electrical current. The electronics in the probe convert the measured current into a digital measurement signal.
- The display unit supplies the probe with auxiliary voltage and processes the measurement signals using a microprocessor. The measurement readings are displayed numerically and outputted as an analogue signal.

Fig. 1 Product components

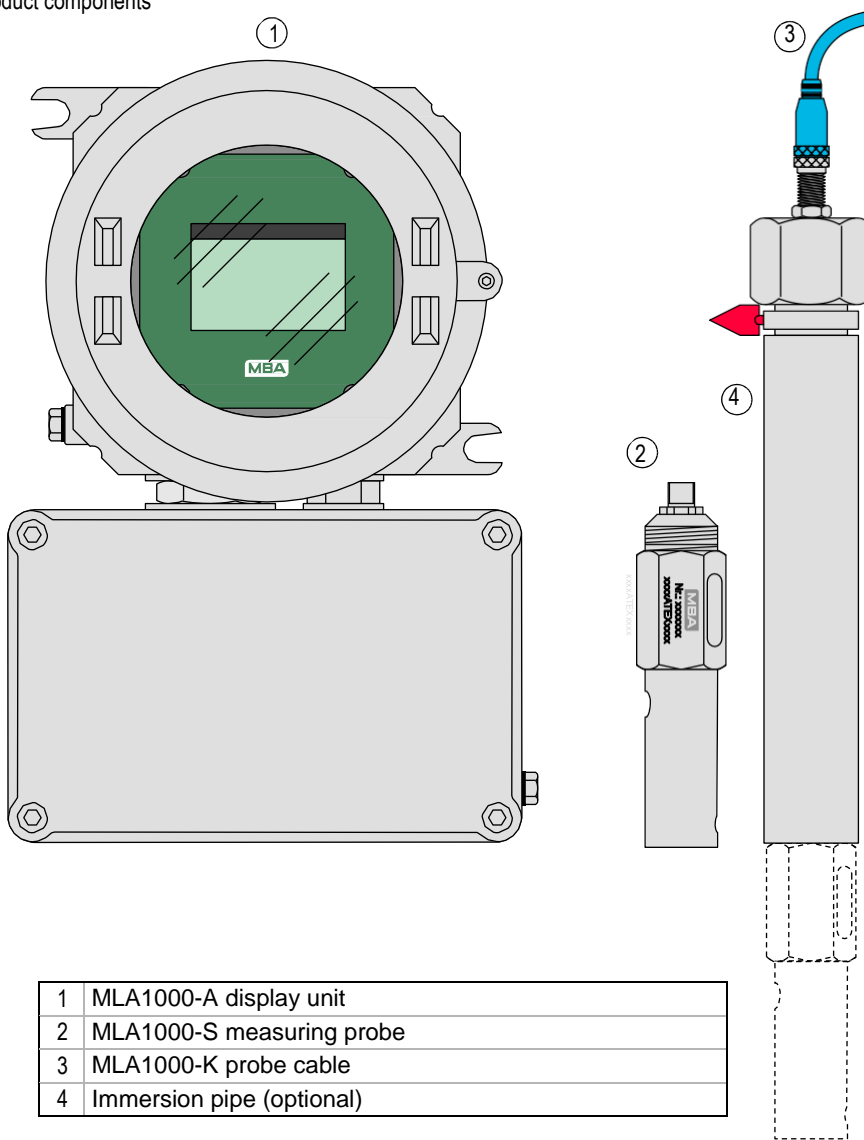

2.3 Product components

2.3.1 MLA1000-S measuring probe

The measuring probe consists of two parts:

- Probe body (hexagonal) with core electrode and connection for the probe cable
- Sheathed electrode (cylindrical) with inlet and outlet opening

The sheathed electrode can be unscrewed for cleaning purposes.

The probe body has a screw thread for attaching the measuring probe.

The temperature sensor and probe electronics are integrated in the sensor body.

 • Technical data → p.24, section 8.1.1.
 • Functional test with ring magnet → p.21, section 6.2.

2.3.2 MLA1000-A display unit

The display unit housing consists of two parts:

- *Top housing*: Display section – contains the electronic components.
- *Bottom housing*: Terminal box – contains the connection terminals.

The top and bottom parts of the housing are separated by a gas-tight seal.

The electronic connection to the measuring probe is intrinsically safe.

 **IMPORTANT:**
 The connection between the housing parts must be supported (certification requirement).
 ► Secure both housing parts of the display unit on a solid subsurface such as a mounting panel (instructions → p.15, section 4.1.2).

 • Technical data → p.24, section 8.1.2
 • Certification for explosion-endangered areas → p.7, section 2.1.3.

2.3.3 MLA1000-K probe cable

- *Length*: The probe cable is available in different lengths. The cable ends are ready for use:
 - Ferrules for connection terminals
 - Receptacle for the measuring probe plug connector
- *Material*: The sheath material used for the selected version of the probe cable must be chemically resistant to the intended measuring liquid. The right type of probe cable is therefore dependent upon the specific application.

 Technical data → p.24, section 8.1.3.

2.3.4 Options

Option	Notes
<input type="checkbox"/> Immersion pipe	– for the measuring probe – with securing chain
<input type="checkbox"/> Mounting bracket	– for the display unit
<input type="checkbox"/> Sliding sleeve	– for the immersion pipe
<input type="checkbox"/> Ball valve	– as sluice for the immersion pipe

2.4 Scope of delivery

Basic components

- Measuring probe (→ p.9, section 2.3.1)
- Display unit (→ p.9, section 2.3.2)
- Probe cable (→ p.9, section 2.3.3)
- Ring magnet for functional testing (→ p.21, section 6.2)

Options / accessories

As ordered (→ p.9, section 2.3.4).



Standard delivery:

- *If delivery includes an immersion pipe:* The immersion pipe, measuring probe and probe cable are already assembled.
- *If delivery includes the mounting bracket:* The immersion pipe and display unit are already assembled.

Documentation

- Certificate of conformity
- Type examination certificate BVS 14 ATEX E047 X (for MLA1000-S probe)
- Type examination certificate BVS 14 ATEX E026 X (for MLA1000-A display unit)
- Operating instructions
- *If delivery includes a ball valve:* Directions for use from the manufacturer of the ball valve
- *If delivery includes a sliding sleeve:* Directions for use from the manufacturer of the sliding sleeve

3 Installation of the Measuring Probe

3.1 Selecting the installation location for the measuring probe

3.1.1 Requirements for the measuring liquid at the installation location

Criterion	Action
<input type="checkbox"/> The measuring liquid should flow at the installation location as homogeneously and evenly as possible.	<ul style="list-style-type: none"> ▶ If possible, install the measuring probe in a long, straight piece of tubing. ▶ After a pipe bend, select a distance equivalent to at least five times the inside diameter of the pipe (5d).
<input type="checkbox"/> The measuring liquid at the installation location should have an homogeneous composition (fully mixed).	▶ Do not install the measuring probe immediately after the mixing stations.
<input type="checkbox"/> The flow velocity must lie between 0.2 and 7 m/s (→ p.24, section 8.1).	▶ Specifications → p.24, section 8.1.
<input type="checkbox"/> Temperature and pressure must be within	



WARNING: Risk of incorrect measurements

The measuring liquid must fulfil the stipulated requirements at the measuring probe as otherwise the readings will not be reliable.



- ▶ Make sure that the measuring fluid at the installation location of the measuring probe fulfils the stipulated requirements.
- ▶ *If the conductance measurement reading is being used to monitor the safe usage of the measuring fluid (in particular for explosion protection purposes):* Make sure that the measurement readings are recognised as being invalid if the measuring liquid at the installation location of the measuring probe does not fulfil the stipulated requirements. If necessary, install appropriate safety mechanisms. Unsafe operating conditions could otherwise arise in the monitored system.

3.1.2 Requirements for the installation location

Criterion	Action
<input type="checkbox"/> The probe cable between the measuring probe and display unit can have a maximum length of 24 m.	▶ Check the length of the supplied probe cable.
<input type="checkbox"/> The immersion pipe may have to be removed after a certain number of operating hours for cleaning or replacing the measuring probe.	<ul style="list-style-type: none"> ▶ Take into account the space required for the piping system. ▶ <i>As required:</i> Install auxiliary devices for disassembling the probe while the piping system is in operation (sliding sleeve[1], ball valve[1]).

[1] Optional (→ p.9, section 2.3.4).

3.2 Preparing the piping system

- ▶ Prepare the installation location so that the work can take place in a safe manner.
- ▶ On the piping system, mount the devices that are required for installing the immersion pipe.
- ▶ *If delivery includes a ball valve:* Install the ball valve in the piping system as described in the directions for use provided by the manufacturer of the ball valve (separate document).

 If delivery includes the optional immersion pipe, the measuring probe is installed in the pipe.

 **WARNING: Danger of explosion**
In explosion-endangered areas:

- ▶ Before beginning with the installation, carry out all the measures that are necessary to safeguard against explosion during the installation work.

 **WARNING: Danger of explosion/fire hazard**
Before welding:

- ▶ Completely empty the piping system.
- ▶ Remove all remaining measuring liquid from the piping system.

Vapours can otherwise occur during welding work that will produce an explosive gas mixture; residues of the measuring liquid could catch fire.

3.3 Installation of the measuring probe with immersion pipe

 Preparations for the installation → p.12, section 3.2.

 **IMPORTANT:**

- ▶ Install the measuring probe so that the required direction of flow for the probe is given.

Otherwise the measurement readings will not be reliable.

Marking the direction of flow

- ▶ Set the marker arrow on the immersion pipe so that it points in the direction of flow for the measuring probe (→ Fig. 2).

Fig. 2 Marker arrow for the direction of flow

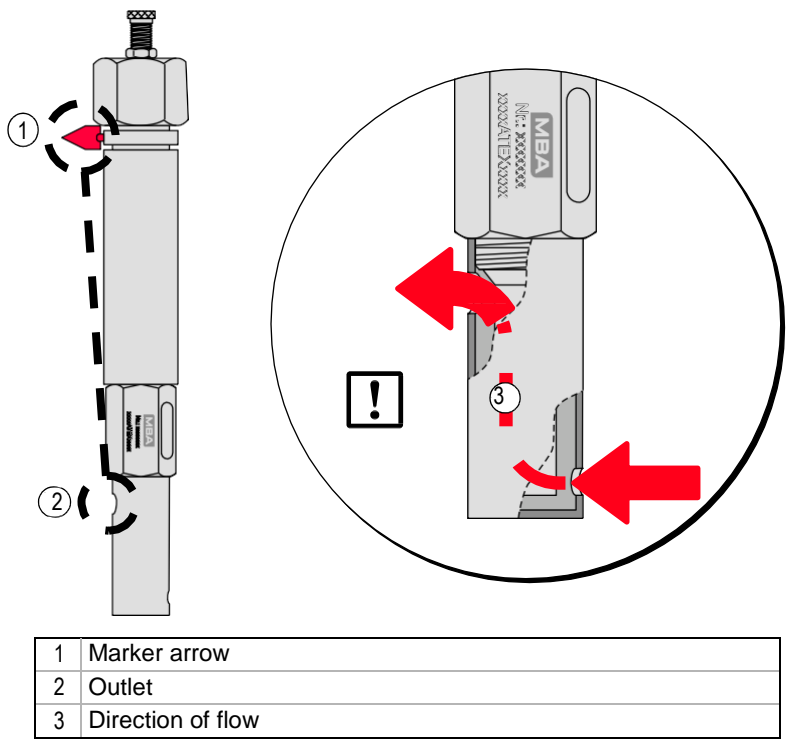

Marking the installation depth

- ▶ On the immersion pipe, mark how far it has to be inserted in the slide fitting so that the measuring probe is correctly positioned in the flowing media.



Slide a sealing ring onto the immersion pipe as marker.

Installing the immersion pipe

- 1 Carefully insert the immersion pipe (with measuring probe) over the device in the piping system up to the marker for the immersion depth.
- 2 Turn the immersion pipe so that the marker arrow points in the direction of flow (→ Fig. 3).
- 3 Affix the immersion pipe in this position.

Connecting the probe cable

- ▶ Connect the probe cable. Secure the plug connector with the coupling nut on the connector.

Fig. 3

Installed measuring probe

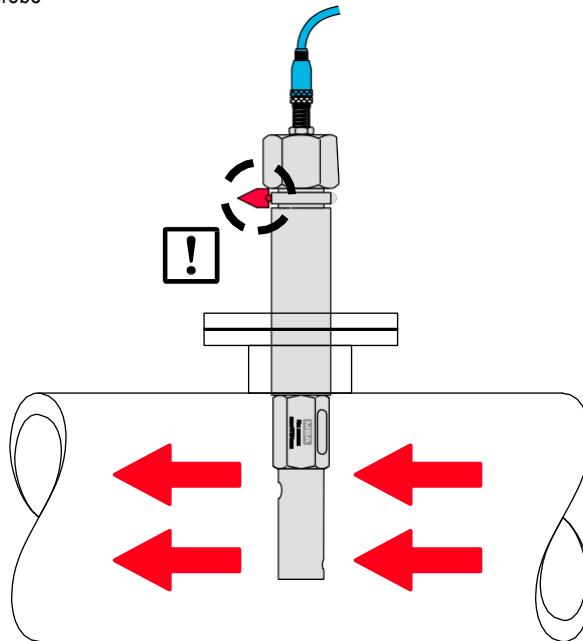

4 Installation of the Display Unit

4.1 Mounting the display unit

Not applicable if the display unit and immersion pipe were delivered already assembled.

4.1.1 Criteria for the mounting location

- The display unit may be installed in a Zone 1 explosion-endangered area. An installation in Zone 0 is not permitted.
- The possible distance between the display unit and measuring probe is dependent upon the length of the supplied probe cable (maximum length: 24 m).
- The display unit must be attached to a wall or a stable mounting.
- The display should be visible while the unit is being operated (for checking the operating status).

4.1.2 Securing the display unit without a mounting bracket

- 1 Secure the top housing of the display unit with 2 screws (Ø 8 mm) to a firm, flat subsurface (e.g. metal wall, metal plate, smooth wall surface of a building).
- 2 Secure the bottom housing with at least 2 screws (Ø 6 mm) to the same subsurface.

4.1.3 Securing the display unit with a mounting bracket

+i The mounting bracket is a delivery option. If the delivery includes a mounting bracket, the display unit is already mounted on it.

- ▶ Affix the mounting bracket with the unit on the immersion pipe (→ p.13, section 3.3).

Fig. 4 MLA1000-A display unit

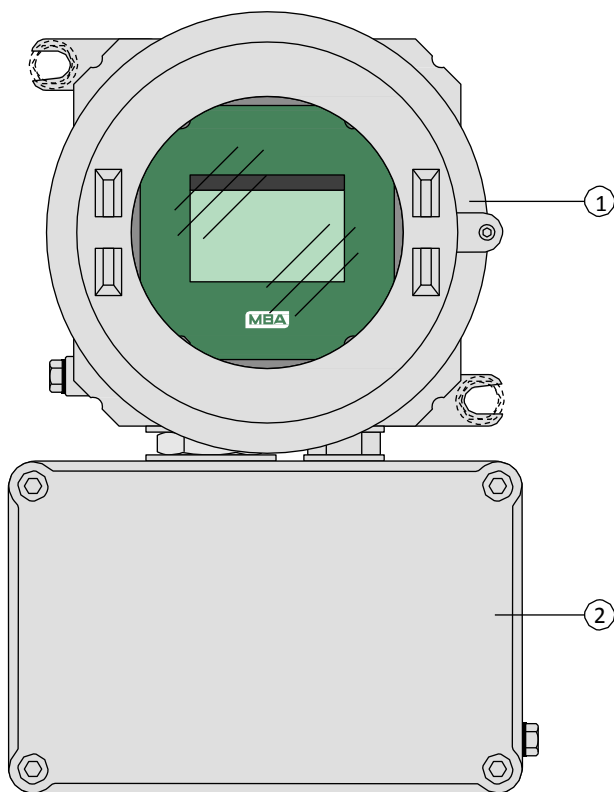

1	Top housing
2	Bottom housing (terminal box)

4.2 Connecting the potential equalisation

- ▶ Join the two connections for the potential equalisation (→ Fig. 5) directly with the main potential (earthing).

4.3 Opening the housing

EX **WARNING: Risk of explosion in explosion-endangered areas**

- ▶ Before opening the terminal box (bottom part of the display unit): The display unit must be disconnected from the power supply. Otherwise there could be a risk of explosion when the terminal box is opened.

- 1 If the display unit is already connected to the power supply: Switch off or disconnect the power supply.
- 2 Open the bottom housing of the display unit.

Fig. 5 Connecting terminals

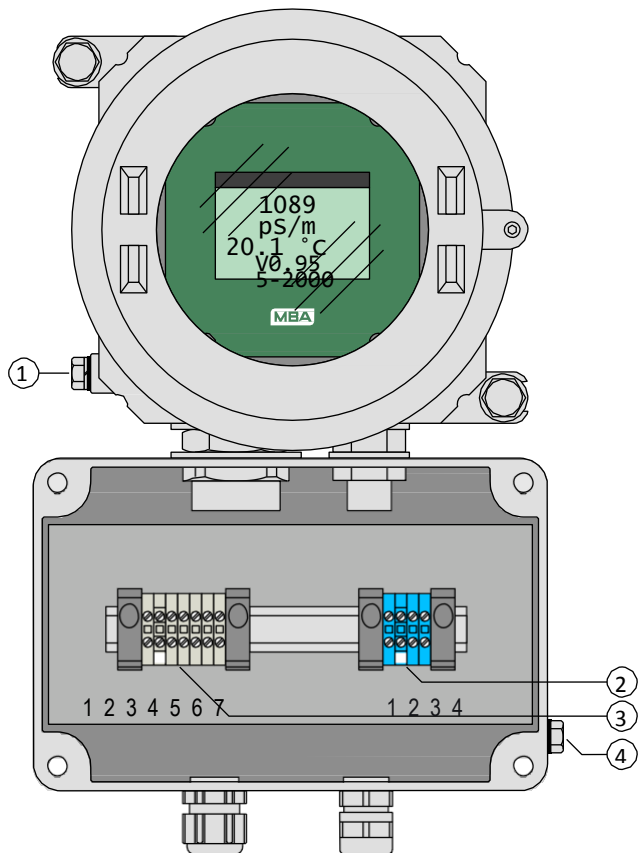

1	Connection for the potential equalisation
2	Connecting terminals for the probe cable (→ p.17, section 4.4.2)
3	Connecting terminals for the supply voltage (→ p. 18, section 4.4.4) and measurement reading outputs (→ p.17, section 4.4.3)
4	Connection for the potential equalisation



- ▶ The top housing of the display unit does not need to be opened. It may only be opened by authorised technicians for repair purposes.
- ▶ Leave the top housing closed.

4.4 Installing the cables

4.4.1 General information about installing the cables

- ▶ Use suitable cable materials → p.24, section 8.1.2.
- ▶ Run all the cables through the cable glands in the bottom housing of the display unit (→ Fig. 2).

When connecting the conductors:

- ▶ Strip the conductor insulation to a length of 7 mm.
- ▶ Tighten the clamping screw on the connecting terminal with a torque of at least 0.3 Nm.

 **WARNING: Danger of explosion**
 The cable glands are subject to approval for explosion-endangered areas.

- ▶ Only use cable materials with a suitable outside diameter.
- ▶ *If the MLA1000 is being used in an explosion-endangered area:* Do not replace the cable glands with cable glands of a different type. Otherwise the certification for explosion-endangered areas will become void and there will be a risk of explosion in such areas.

4.4.2 Connecting the probe cable

- ▶ Connect the probe cable to the blue 4-pole terminal block (→ Table 1).

Table 1 Connecting terminals for the probe cable

4-pole terminal block	
Connecting terminal	Colour code for probe cable
1	brown
2	black
3	blue
4	white

4.4.3 Connecting the measurement reading outputs

The measurement reading outputs continually give out the actual measured values. The physical measuring range is outputted in the signal range between 4 and 20 mA.

- ▶ Connect the measurement reading outputs as shown in the terminal diagram (→ Table 2).

Table 2 Output signals for the measurement reading outputs

Output signal	Explanation
0 mA	Electrical connection has been interrupted. MLA1000 is malfunctioning or defective.
4 to 20 mA	Current measurement reading
24 mA	Measurement readings cannot be generated. <i>Possible causes:</i> – The true physical value is greater than the end value of the measuring range (overflow).

 Permitted output load → p.24, section 8.1.

4.4.4 Connecting the supply voltage

- ▶ Install a fuse in the power supply lead for the MLA1000.
Fuse rating: max. 5 A (power consumption → p.24, section 8.1.2).
- ▶ Connect the power supply as shown in the terminal diagram (→ Table 3).

 ▶ Make sure that the current fed into the power supply lead cannot exceed 5 A.

 Specification for the power supply → p.24, section 8.1

Table 3 Connecting terminals for the measurement reading output and power supply

7-pole terminal block	
Connecting terminal	Function
1	Power supply +24 V DC
2	Power supply GND
3	Measurement reading output for temperature (+ mA)
4	Measurement reading output for conductance (+ mA)
5	Measurement reading outputs for GND (-mA)
6	
7	– no function –

4.4.5 Closing the cable glands and housing

After installing the cables:

- ▶ Seal the cable glands.
- ▶ Close the housing.

 **WARNING: Danger of explosion**
Before putting the unit into operation in explosion-endangered areas:

- ▶ Seal all the cable glands so that they are "flame-tight" (practically gas-tight).
- ▶ Either close off any unused cable glands with a closure plug or replace them completely with sealing caps.
 - *Closure plugs:* Select suitable closure plugs for the permitted cable diameters and install them instead of a cable.
 - *Sealing caps:* Select sealing caps with thread M20 x 1.5 which are certified for usage in explosion-endangered areas. Apply suitable adhesive to the threads and sealing surfaces.
- ▶ Tightly close the display unit housing.

Otherwise there could be a risk of explosion.

5 Operation

5.1 Putting the MLA1000 into operation

- 1 Make sure that the display unit housing is tightly closed.
- 2 Switch on the supply voltage.
- 3 Wait for the display to light up after switching it on (→ p.19, section 5.3.1).
- 4 Check the operating status (→ section 5.2).

5.2 Checking the operating status

5.2.1 Indications for a safe operating status

- 1 The measuring liquid fulfils the requisite operating conditions at the measuring probe (→ p.11, section 3.1.1, e.g. flow velocity).
- 2 The display on the display unit shows the measurement readings (→ section 5.3.2).
- 3 Measurement readings are returned at the measurement reading outputs.

 Testing the measuring function → p.21, section 6.2.

5.2.2 Indications for an unsafe operating status

- Nothing is shown on the display of the display unit.
- A malfunction is shown on the display (→ p.20, section 5.3.3).
- At least one measurement reading output returns "0 mA".
- At least one measurement reading output returns "24 mA".
- The measuring liquid does not have the required flow velocity at the measuring probe (→ section 5.3.2).
- The measuring liquid is not within the permitted temp. range at the measuring probe (→ section 5.3.2).
- Measurement readings are being displayed that cannot be correct.
- At least one measurement reading output returns readings that cannot be correct.

5.3 Display screens

5.3.1 Screen after switching on

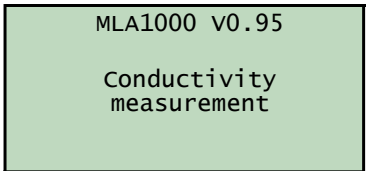
	<p>Explanation: MLA1000 is starting up (approx. 3 seconds).</p> <p>Actions:</p> <ul style="list-style-type: none"> ▶ Wait until the operating screen appears (→ section 5.3.2). ▶ <i>If the operating screen does not appear:</i> Refer to the information about the malfunction screens (→ section 5.3.3).
---	---

5.3.2 Operating screen

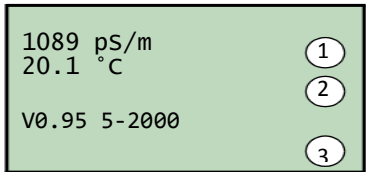
	<p>Explanation: MLA1000 is in the normal operating status (measuring mode).</p> <p>1 = actual conductance measurement reading (sample value) 2 = actual temperature measurement reading (sample value) 3 = version number of the firmware (example)</p> <p>Actions:</p> <ul style="list-style-type: none"> ▶ Check/ensure that the requirements for safe operation are fulfilled (see warning note).
---	---

 **WARNING: Requirements for safe operation**

- The flow velocity of the measuring liquid at the measuring probe must be between 0.2 and 7 m/s.
- The measuring liquid temperature must be between -20 and +60 °C. Otherwise the measurement readings will not be reliable.

5.3.3 Malfunction screens

<p style="text-align: center;">High pS/m 20.1 °C V0.95 5-2000</p>	<p>Explanation: The actual conductance measurement reading is greater than 2000 pS/m.</p> <p>Effects:</p> <ul style="list-style-type: none"> » The measurement reading output for the conductance is returning 24 mA. <p>Recommended actions:</p> <ul style="list-style-type: none"> ▶ Check whether the conductance of the measuring liquid at the measuring point could actually be so high. ▶ Check whether the measuring liquid is passing by the probe properly (→ p.13, 3.3). ▶ Clean the measuring probe (→ p.22, section 6.3).
<p style="text-align: center;">Low pS/m 20.1 °C V0.95 5-2000</p>	<p>Explanation: The actual conductance measurement reading is less than 5 pS/m.</p> <p>Effects:</p> <ul style="list-style-type: none"> » The measurement reading output for the conductance is returning 0 mA. <p>Recommended actions:</p> <ul style="list-style-type: none"> ▶ Check whether the measuring fluid is flowing (the flow velocity is at least 0.2 m/s). ▶ Check whether the conductance of the measuring liquid at the measuring point could actually be so low. ▶ Check whether the measuring liquid is passing by the probe properly (→ p.13, 3.3).
<p style="text-align: center;">Sensor Error V0.95 5-2000</p>	<p>Explanation: The measuring probe is malfunctioning.</p> <p>Effects:</p> <ul style="list-style-type: none"> » The measurement reading outputs are returning 0 mA. <p>Recommended actions:</p> <ul style="list-style-type: none"> ▶ Carefully check the electrical connection between the display unit and the measuring probe (condition of the connecting cable, terminals; <i>after installation</i>: wiring/terminal assignment). ▶ <i>If that does not help</i>: Notify the manufacturer (have the probe replaced).
<p style="text-align: center;">Fatal Error V0.95 5-2000</p>	<p>Explanation: The MLA1000 is not functioning.</p> <p>Effects:</p> <ul style="list-style-type: none"> » The measurement reading outputs are returning 0 mA. <p>Recommended actions:</p> <ul style="list-style-type: none"> ▶ Shut down and disconnect the MLA1000 and then put it back into operation. ▶ <i>If that does not help</i>: Clean the measuring probe (→ p.22, section 6.3). ▶ <i>If that does not help</i>: Notify the manufacturer.

6 Maintenance

6.1 Removing the immersion pipe (with measuring probe)



- The MLA1000 does not have to be shut down for this work.
- If the MLA1000 remains in operation, the measuring function can be tested using simple means (→ section 6.2).



CAUTION: Possible danger to health

If the measuring liquid could represent a health risk:

- ▶ Before removing the immersion pipe, take the appropriate protective measures suitable for the measuring liquid (e.g. safety goggles, protective clothing, respirator).

For installations without a ball valve

- 1 Take the piping system out of operation (stop the liquid flow).
- 2 Remove the immersion pipe from the unit.

For installations with a ball valve

- ▶ Follow the instructions given by the manufacturer of the ball valve (separate document).

6.2 Testing the measuring function



- This procedure tests the electronic functionality of the measuring probe and display unit.
- The supplied ring magnet is required for this procedure.
- Adjustment (electronic adjustment of the measuring probe and display unit) are not necessary during operation.



A measuring probe that is clean, dry and functioning correctly the device displays "low" in atmospheric air.

- 1 Make sure
 - that the sheathed electrode is firmly screwed onto the measuring probe,
 - that the probe is clean and dry,
 - that the probe is properly connected to the display unit (probe cable, plug-in connection on the probe).

- 2 Place the ring magnets on the surface of the measuring probe opposite the labelled area.

For the test value for electrical conductivity, please refer to the test certificate.

- ▶ *If the test value is not within the tolerance range:* Notify the manufacturer's customer service or return the MLA1000 to the manufacturer for repair.

6.3 Cleaning the measuring probe



WARNING: Hazard in explosion-endangered areas
▶ Do not perform cleaning work in explosion-endangered areas.



IMPORTANT: Risk of damage from rough handling

- Exerting mechanical pressure on the probe body can destroy the plastic moulding in the body (cause it to rupture).
- Deformations will lead to incorrect measuring results.
- Dirt in scratches can falsify the measurement readings.
- ▶ Do not deform the probe body or sheathed electrode.
- ▶ Do not clamp the measuring probe in a vice - neither the probe body nor the sheathed electrode.
- ▶ Only use tools with a soft surface.
- ▶ Make sure that the plastic moulding is not scratched.

Fig. 6 MLA1000-S measuring probe

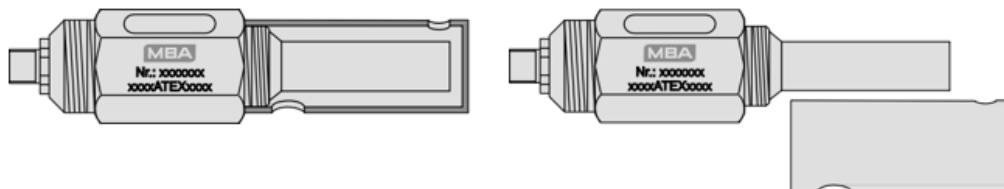



- 1 Unscrew the sheathed electrode.
If the sheathed electrode cannot be unscrewed by hand: Use a tool with a soft surface. Only apply pincer-like tools at the bottom-most rim (closed end) of the sheathed electrode.
- 2 Carefully clean all the surfaces of the probe body and sheathed electrode using a soft cloth moistened with a suitable solvent (→ Table 5).



The cleanliness of the parts determines the quality of the conductance measurements.

Table 5 Cleaning agents

 Suitable solvents	Unsuitable solvents
Ethanol (ethyl alcohol) Isopropyl alcohol Benzene	Methanol Acetone Chlorine hydrocarbons (CHC) Acids



IMPORTANT: Risk of damage from solvents
▶ Only use suitable cleaning agents. Other substances can damage the measuring probe.



WARNING: Danger due to damaged measuring probes
▶ Do not use damaged measuring probes in explosion-endangered areas.

6.4 Reinstalling the measuring probe

- 1 Reassemble the measuring probe and immersion pipe (→ p.22, section 6.4).
- 2 Reinstall the immersion pipe (→ p.13, section 3.3).

7 Troubleshooting

7.1 If the MLA1000 does not function at all ...

Possible cause	Remarks
The power supply has failed.	▶ Check the mains power supply (e.g. external master switch, external fuse, connecting cable).
The operating temperatures are incorrect.	▶ Check the ambient temperatures (permitted ranges → p.24, section 8.1).
The internal software is not functioning.	▶ Switch off the supply voltage to the MLA1000 and then switch it back on again (reset) after a few seconds. <i>Note:</i> Can only occur in conjunction with complex internal malfunctions or extreme external influences (e.g. strong electromagnetic interference pulse).
The internal overcurrent fuse (PTC resettable fuse) has been tripped.	1 Switch off the supply voltage to the MLA1000. 2 Wait for several minutes. 3 Put the MLA1000 back into operation (→ p.19, section 5.1). <i>If the overcurrent fuse is tripped again:</i> The MLA1000 is defective. ▶ Have it repaired.

7.2 If the measurement readings are obviously incorrect...

Possible cause	Remarks
The MLA1000 is not ready for operation.	▶ Check the operating status (→ p.19, section 5.2).
The requirements for the measuring liquid are not being fulfilled (e.g. flow velocity).	▶ Check the operating conditions at the measuring probe (requirements → p.11, section 3.1.1).
<i>If only the case at the measurement reading output:</i> The output load is too great.	▶ Make sure that the internal resistance of the connected devices does not exceed the permitted output load (→ p.24, section 8.1).
The measuring probe is soiled.	▶ Visually check the condition of the measuring probe. ▶ Clean the probe if necessary (→ p.22, section 6.3).
The measuring probe is defective.	▶ Visually check the condition. ▶ Test the measuring function (→ p.21, section 6.2).
The probe cable is damaged.	▶ Check the probe cable. ▶ Check the probe cable connections.

8 Appendix

8.1 Technical data

8.1.1 MLA1000-S measuring probe

Operating conditions for the measuring liquid

Flow velocity	
– minimum:	0.2 m/s
– maximum:	7 m/s
Permitted temperature:	-20 to +60 °C
Permitted pressure:	0 to +16 bar (versus atmosphere)

8.1.2 MLA1000-A display unit

Housing, ambient conditions

Protection class:	IP 66
Permitted ambient temperature:	-20 to +55 °C
Permitted ambient pressure:	atmospheric

Auxiliary power

Supply voltage:	24 V DC ± 10 %
Power consumption:	max. 150 mA

Suitable connecting cable

Conductor cross-section:	0.5 to 1.5 mm ²
Cable diameter:	6 to 12 mm

Measurement reading display

Measuring range (standard)	
– for conductance:	0 to 2000 pS/m
– for temperature:	-20 to +60 °C

Measurement reading outputs

Physical output area (standard)	
– for conductance:	0 to 2000 pS/m
– for temperature:	-20 to +60 °C
Electronic output range:	4 to 20 mA
Electronic signal range:	0 to 24 mA
Permitted output load:	0 to 500 Ω

8.1.3 MLA1000-K probe cable

Conductor cross-section:	4x 0.5 mm ²
Sheath material:	PVC, PUR, PE or TPE
Maximum length:	24 m

8.2 Certification/suitability test

Measuring probe

Type examination certificate:	BVS 14 ATEX E047 X
Identification marking:	 II 1G Ex ia IIB T4 Ga

Display unit

Type examination certificate:	BVS 14 ATEX E026 X
Identification marking:	 II 2(1)G Ex de [ia Ga] IIB T4 Gb

8.3 Disposal Information

- The display unit contains electronic components that can be removed and disposed of separately.
- The measuring probe contains electronic components that are inseparably connected to the probe body (plastic cast moulding).
- The conductor material of the probe cable could be recycled.

Index

- A**
Connecting cable
– suitable cable material 24
– installation instructions 17
Scope of application 7
Application restrictions 7
Display unit
– mounting 15
– description 9
– cable installation 17
– connecting the potential equalisation 16
– technical data 24
- B**
Type examination certificate 24
Intended use 7
Operating display 19
Checking the operating condition (safe/unsafe) 19
- D**
Display screens 19 - 20
Direction of flow 13
- E**
Installation location 11
Removing the immersion pipe 21
Installing the immersion pipe 14
Disposal 25
Ex. identification 24
- F**
Fatal Error 20
Fault detection (troubleshooting). 23
Functional test 21
Operating principle 8
- G**
Glossary 3
- H**
High (malfunction display) 20
Auxiliary power 24
- I**
Operational start-up procedure 19
Installation
– mounting the display unit 15
– selecting the installation location
 for the measuring probe 11
– closing the housing 18
– information about installing the cables 17
– cable glands 18
– installing the measuring probe
 with immersion pipe 13
– connecting the measurement reading outputs 17
– preparing the piping system 12
– connecting the probe cable 17
– supply voltage, external fuse 18
Maintenance
– removing the immersion pipe/measuring probe 21
– testing the measuring function 21
– cleaning the measuring probe 22
- K**
Cable connection see "Connecting cable"
Cable glands
– properly plugging 18
– technical data 24
Marking (certification) 24
- L**
Scope of delivery 10
Low (malfunction display) 20
- M**
Marker arrow 13 - 14
Measuring liquid
– requirements at the installation location 11
– suitable liquids 7
Testing the measuring function 21
Measuring probe
– requirements for the measuring liquid 11
– description 9
– operating conditions for the measuring liquid 24
– direction of flow 13
– selecting the installation location 11
– installing with immersion pipe 13
– cleaning 22
– technical data 24
Removing the measuring probe 21
Measuring methods 25
Measuring methods (operating principle) 8
Measurement reading display 19
Measurement reading outputs
– connecting terminals 17 - 18
– technical data 24
- O**
Options 9 - 10
- P**
Connecting the potential equalisation 16
Product description 7
Product components 8 - 9
- R**
Preparing the piping system 12
- S**
Sensor error 20
Safe usage 5
Safety instructions 5
– for operation 5
– for installation 5
– for safe usage 5
Fuse
– external (for supply voltage) 18
– internal overcurrent fuse 23
Probe cable
– connecting terminals 17
– length, material 9
– technical data 24
Malfunction screens (display) 20
Troubleshooting 23
Power consumption 24
Direction of flow 13 - 14
- T**
Technical data 24
Test 21
- V**
Responsibilities of the user 6
Supply voltage
– connecting terminals 18
– external fuse 18
– technical data 24
- Z**
Accessories 10
Certification
– description 7
– identification marking 24

MLA1000

MBA Instruments GmbH
Friedrich-List-Str. 3-7, 25451 Quickborn, Germany
Phone +49 4106/123 88-80
info@mba-instruments.de

